

Food Holding Equipment SafeBox Hold with sliding doors

ITEM # _____

MODEL # _____

NAME # _____

SIS # _____

AIA # _____

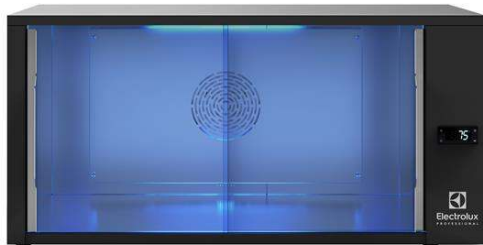
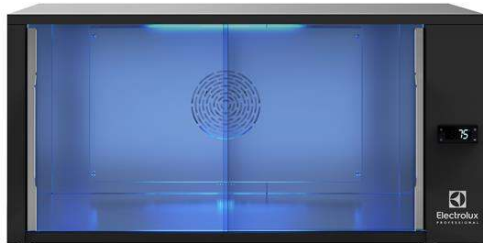
240425 (SBXE5CS)

 SafeBox Hold Warming
 Container for food pick up,
 take away and delivery -
 Schuko plug

Short Form Specification

Item No. _____

Designed to serve restaurateurs active in take-away and delivery operations. Can accommodate large paper shoppers, paper boxes or pizza boxes (pizza diameter up to 33 cm). Features a ventilated heat system to envelop the packaged meals with hot air and preserve the original taste. The fast heat recovery in combination with the UVC lamp mounted on the ceiling also serves bactericidal and viricidal purposes. UVC lamp switch off button. 2 sliding doors ensure comfort of operations and at the same time reduce space occupancy. Possibility to stack up to 3 units thus increasing capacity according to the customer's requirements. Prearranged for installation on site of shelf accessory. Schuko plug.

Main Features

- Keeps multiple packaged meals ready for pickup, preserving the food quality and safety.
- It is designed to serve restaurateurs active in take-away and delivery operations.
- Can accommodate large paper shoppers, paper boxes or pizza boxes (pizza diameter up to 33 cm).
- Features a ventilated heat system to envelop the packaged meals with hot air and preserve the original taste.
- The fast heat recovery in combination with the UVC lamp mounted on the ceiling also serves bactericidal and viricidal purposes.
- 2 sliding doors ensure comfort of operations and at the same time reduce space occupancy. The UVC lamp is activated only when the doors are properly closed (verified via dedicated sensors). The handles incorporate a photocatalytic coating to guarantee antibacterial activity.
- The unit fits 600 mm deep counters and does not require extra space for ventilation.
- The temperature can be set on the back of the unit and ranges from 60 to 85°C.
- It's possible to stack up to 3 units thus increasing capacity according to the customer's requirements with no extra space occupancy.
- The stacked units can be connected on the back and transfer energy from one to the others, requiring just 1 cord and 1 plug for the whole execution.

Optional Accessories

- Shelf for SafeBox Hold with sliding door PNC 922398
- Installation kit for wall fixing (for stacked appliances) PNC 922418

APPROVAL: _____

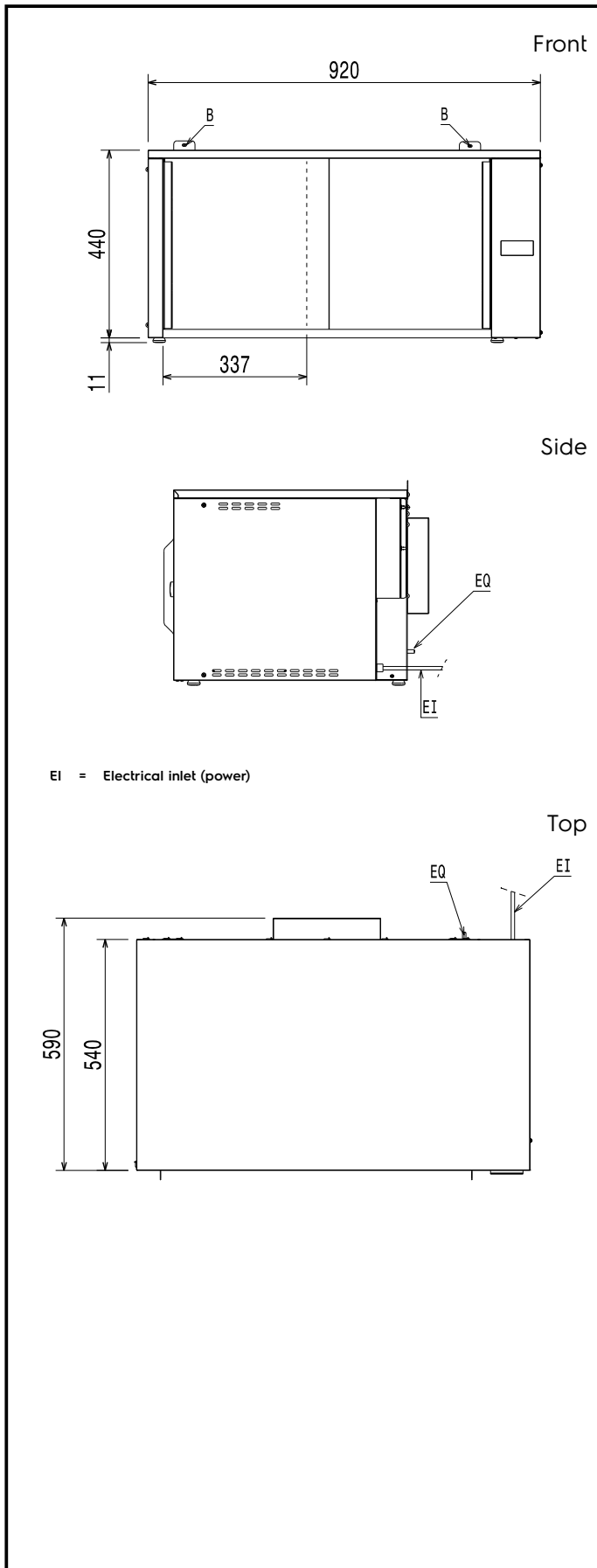

Electric

Supply voltage:	
240425 (SBXES5CS)	220-240 V/1 ph/50 Hz
Installed Power :	0.59 kW
Plug type:	CE-SCHUKO

Key Information:

External dimensions, Width:	920 mm
External dimensions, Depth:	590 mm
External dimensions, Height:	450 mm
Net weight:	36 kg
Internal dimensions, Width:	770 mm
Internal dimensions, Depth:	410 mm
Internal dimensions, Height:	350 mm
Waterproof index:	IPX3

Sustainability

Noise level:	48 dBA
---------------------	--------